

AIRTOWEL®

Hygiene Systems

ABN 16 099 940 548

Fax: 3355 9411

Ph: 3355 9400

PO BOX 2335, Brookside Centre, QLD 4053

EZYFIT

MODULAR GRAB RAIL SYSTEM

CONSTRUCTED OF 304 STAINLESS STEEL

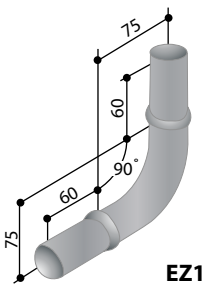

EZ1

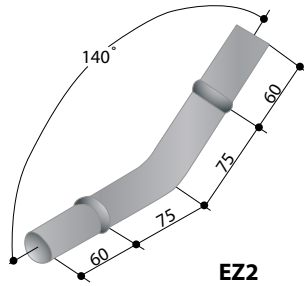

EZ2

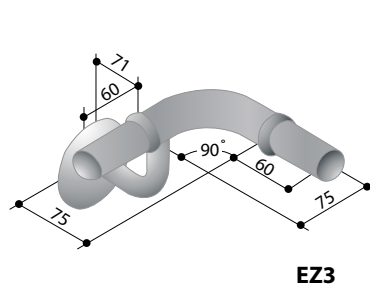

EZ3

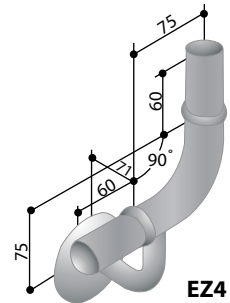

EZ4

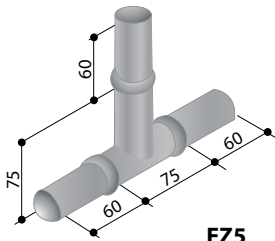

EZ5

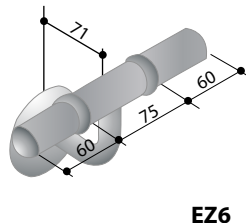

EZ6

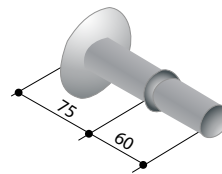

EZ7

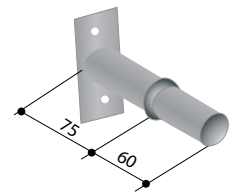

EZ7FP

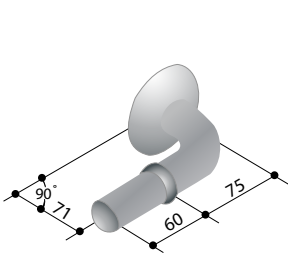

EZ8

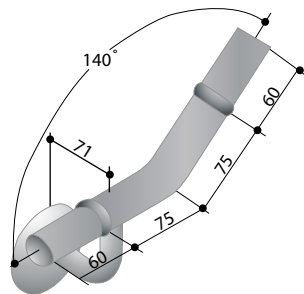

EZ9

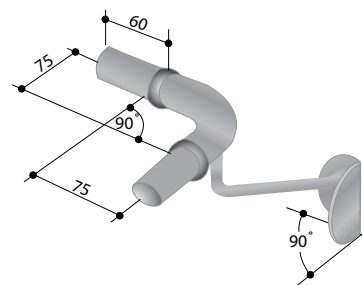

EZ10

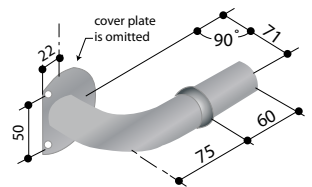

EZ15

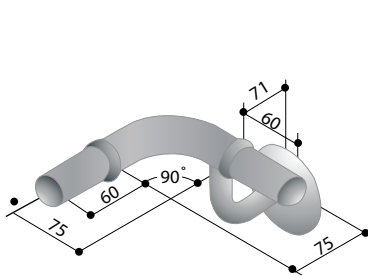

EZ16

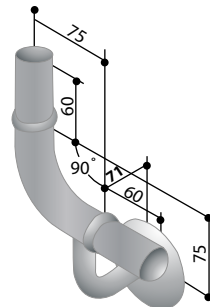

EZ17

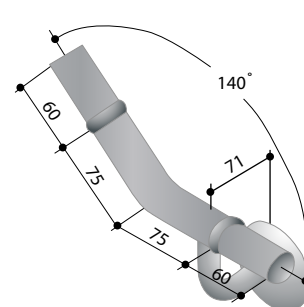

EZ18

SYSTEM COMPONENTS